

Volume - Mixed Shapes

Find the exact volume of each shape.

1)

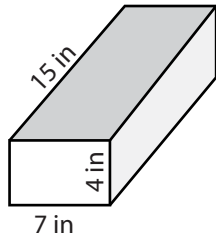

Volume = _____

2)

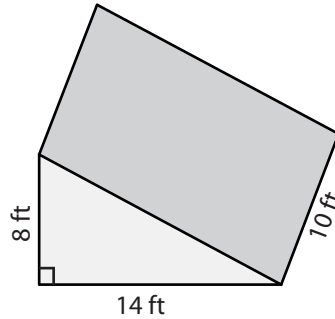

Volume = _____

3)

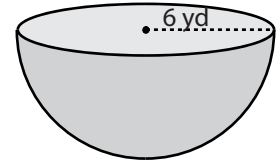

Volume = _____

4)

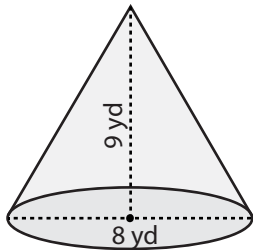

Volume = _____

5)

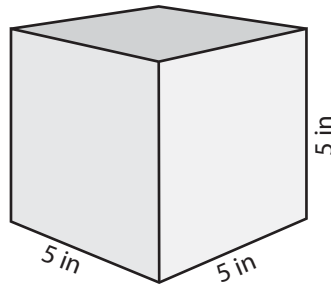

Volume = _____

6)

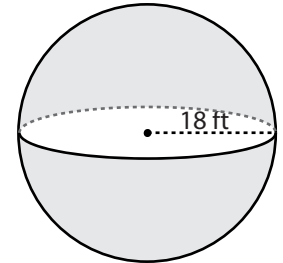

Volume = _____

7)

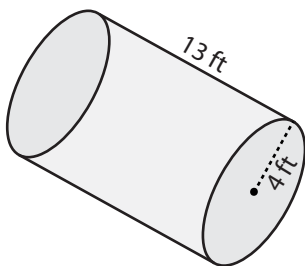

Volume = _____

8)

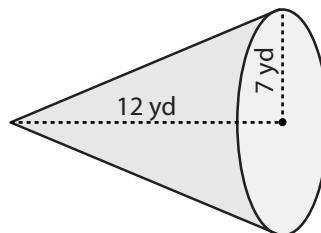

Volume = _____

9)

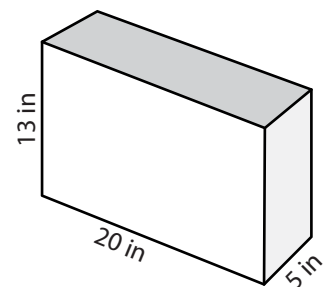

Volume = _____