

# Angles on a Straight Line

Find the measure of the unknown angle.

1)

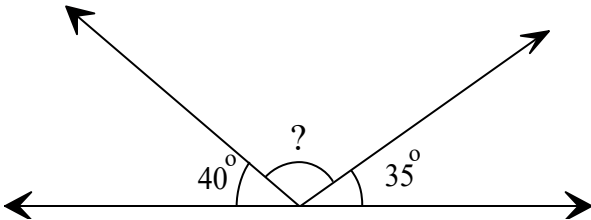

2)

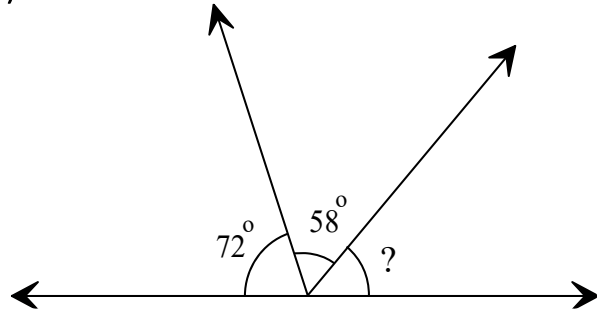

3)

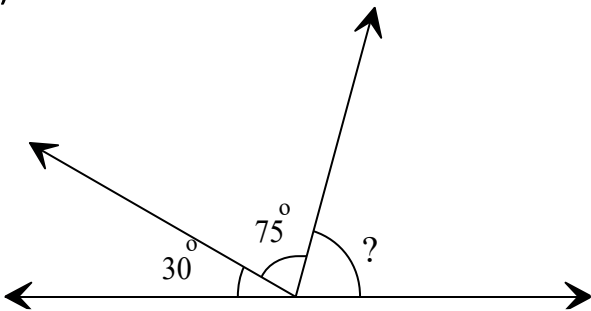

4)

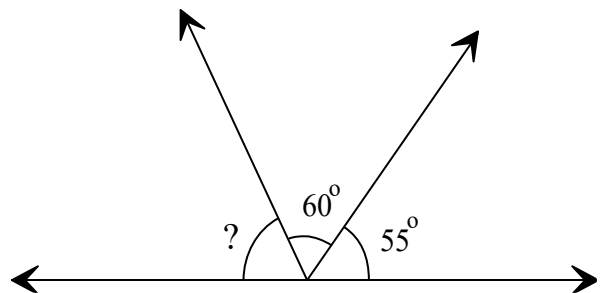

5)

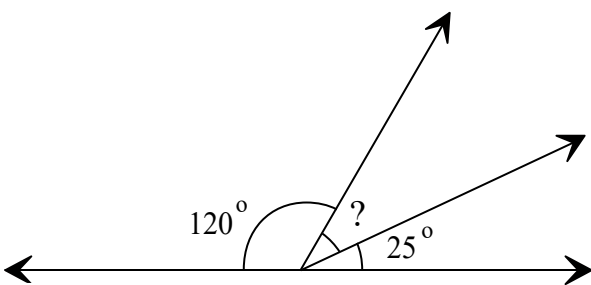

6)

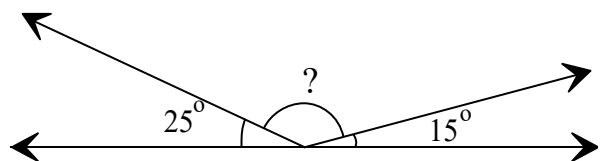

7)

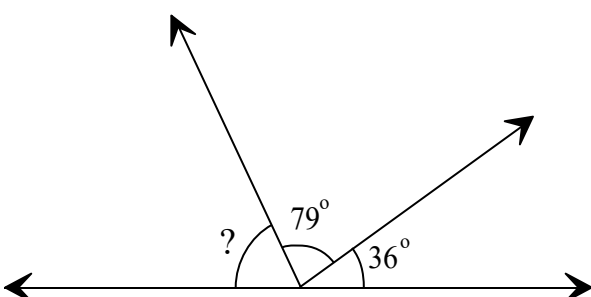

8)

